

DIGITAL INSIDE GROOVE CALIPER

SERIES 132

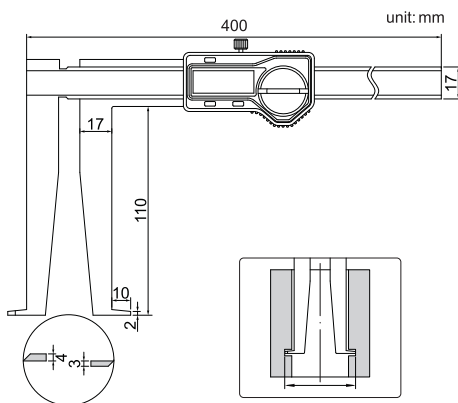

bore sizes to be measured

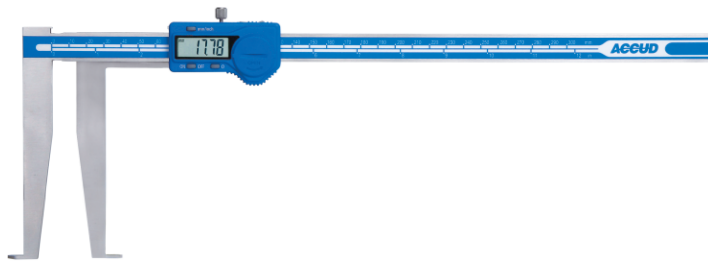
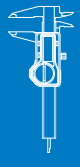
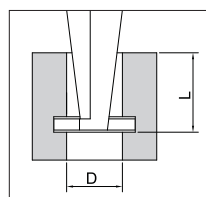

(mm)	
D	L
Ø25	<50
Ø26	<60
Ø27~300	<110

- ◆ Measure diameter of grooves inside bores
- ◆ Resolution: 0.01mm/0.0005"
- ◆ Automatic power on/off
- ◆ Buttons: on/off, zero, mm/inch
- ◆ Data output (cable code: 100-11 or 100-12)
- ◆ Made of stainless steel

Code	Range	Accuracy
132-012-11	25-300mm	±0.05mm

DIGITAL TUBE THICKNESS CALIPER

137

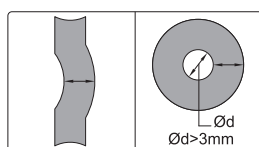
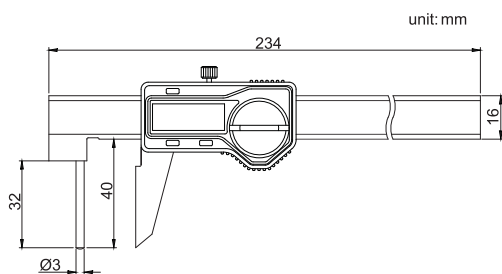
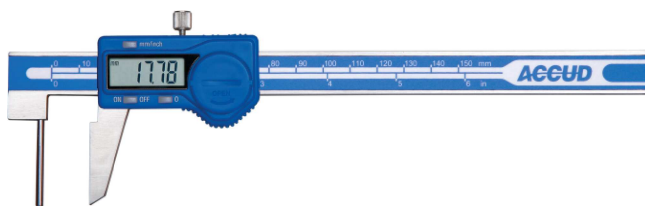

- ◆ Measure the wall thickness
- ◆ Resolution: 0.01mm/0.0005"
- ◆ Automatic power on/off
- ◆ Buttons: on/off, zero, mm/inch
- ◆ Data output (cable code: 100-11 or 100-12)
- ◆ Made of stainless steel

Code	Range	Accuracy
137-006-11	0-150mm/0-6"	±0.05mm